



ORIENT

Photo coupler

Product Data Sheet

MPN: OR-3H7 series of CG

Customer: _____

Date: _____

SHENZHEN ORIENT COMPONENTS CO.,LTD.

Block A 3rd Floor No.4 Building, Tian'an Cyber Park, Huangge Rd, LongGangDist, Shenzhen, GD

TEL: 0755-29681816

FAX: 0755-29681200

www.orient-opto.com

Preliminary

This datasheet is a preliminary design specification, and the formal specifications are subject to the recognition letter with jointly signed

1. Features

- (1) Current transfer ratio(CTR) : MIN. 50% at $I_F = 5\text{mA}$, $V_{CE} = 5\text{V}$, $T_a=25\text{ }^\circ\text{C}$
- (2) High input-output isolation voltage.($V_{ISO}=3,750\text{Vrms}$)
- (3) Collector and emitter Voltage : 80V(MIN)
- (4) Operating Temperature :-55 $^\circ\text{C}$ to 125 $^\circ\text{C}$
- (5) ESD pass HBM 8000V/MM 2000V
- (6) Safety approval
 - UL approved(No.E323844)
 - VDE approved(No.40029733)
 - CQC approved (No.CQC19001231256)
- (7) AEC-Q101 qualified
- (8) In compliance with RoHS, REACH standards
- (9) MSL Class I



2. Instructions

The OR-3H7-(CG) series device contains an infrared led and a photo transistor detector.They are encapsulated in a 4-pin SOP, free of halogens and Sb_2O_3

3. Application Range

- (1) Mixed PCB substrate requiring high density installation
- (2) Programmable controller
- (3) System apparatus and measuring instruments

4. Functional Diagram

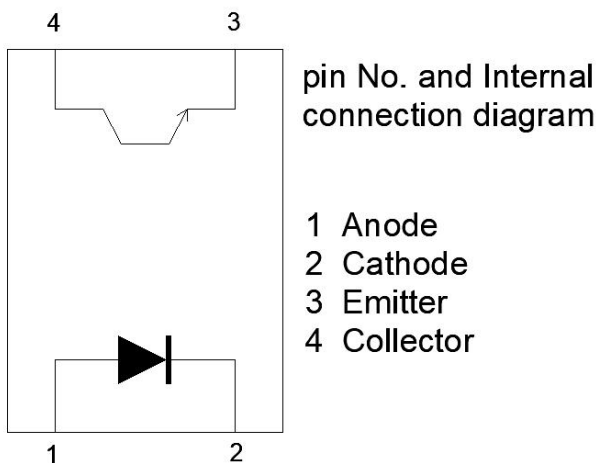

5. Max Absolute rated Value (Normal Temperature=25°C)

Parameter		Symbol	Rated Value	Unit
Input	Forward Current	I_F	50	mA
	Peak forward current(t=10us)	I_{FP}	1	A
	Reverse Voltage	V_R	6	V
	Power Dissipation	P	70	mW
	Junction Temperature	T_j	125	°C
Output	Collector and emitter Voltage	V_{CEO}	80	V
	Emitter and collector Voltage	V_{ECO}	7	
	Collector Current	I_C	50	mA
	Power Dissipation	P_C	150	mW
	Junction Temperature	T_j	125	°C
Total Power Dissipation		P_{tot}	200	mW
*1 Insulation Voltage		V_{iso}	3750	Vrms
Maximum repetitive peak isolation voltage		V_{IORM}	630	V
Operating Temperature		T_{opr}	-55 to + 125	°C
Storage Temperature		T_{stg}	-55 to + 150	
*2 Soldering Temperature		T_{sol}	260	

*1. AC For 1 Minute, R.H. = 40 ~ 60%

Isolation voltage shall be measured using the following method.

- (1) Short between anode and cathode on the primary side and between collector and emitter on the secondary side
- (2) The isolation voltage tester with zero-cross circuit shall be used.
- (3) The waveform of applied voltage shall be a sine wave.

*2.soldering time is 10 seconds

6. Opto-electronic Characteristics(Normal Temperature=25°C)

Parameter		Symbol	Min	Typ.*	Max	Unit	Condition
Input	Forward Voltage	V_F	---	1.2	1.4	V	$I_F=20mA$
	Reverse Current	I_R	---	---	5	μA	$V_R=5V$
	Terminal Capacitance	C_t	---	30	250	pF	$V=0, f=1KHz$
Output	Collector Dark Current	I_{CEO}	---	---	100	nA	$V_{CE}=20V$ $I_F=0mA$
	Collector-Emitter Breakdown Voltage	BV_{CEO}	80	---	---	V	$I_C=0.1mA$ $I_F=0mA$
	Emitter-Collector Breakdown Voltage	BV_{ECO}	7	---	---	V	$I_E=0.1mA$ $I_F=0mA$
Transforming Characteristics	*1 Current Transfer Ratio	CTR	50	---	600	%	$I_F=5mA$ $V_{CE}=5V$
	Collector Current	I_C	2.5	---	30	mA	
	Collector-Emitter Saturation Voltage	$V_{CE(sat)}$	---	---	0.3	V	$I_F=8mA$ $I_C=2.4mA$
	Insulation Impedance	R_{iso}	5×10^{10}	1×10^{11}	---	Ω	DC500V 40~60%R.H.
	Floating Capacitance	C_f	---	0.6	1	pF	$V=0, f=1MHz$
	Rise Time	t_r	---	3	18	μs	$V_{CE}=10V$ $I_C=2mA$ $R_L=100\Omega$
	Fall Time	t_f	---	4	18	μs	

- Current Conversion Ratio = $I_C / I_F \times 100\%$

7. Rank table of current transfer ratio CTR

CTR Rank	Min.	Max.	Condition	Unit
A	80	160	IF=5mA, V _{CE} =5V, Ta=25°C	%
	30	100	IF=1mA, V _{CE} =5V, Ta=25°C	
B	130	260	IF=5mA, V _{CE} =5V, Ta=25°C	
	50	180	IF=1mA, V _{CE} =5V, Ta=25°C	
C	200	400	IF=5mA, V _{CE} =5V, Ta=25°C	
	80	300	IF=1mA, V _{CE} =5V, Ta=25°C	
D	300	600	IF=5mA, V _{CE} =5V, Ta=25°C	
	120	400	IF=1mA, V _{CE} =5V, Ta=25°C	
No Mark	50	600	IF=5mA, V _{CE} =5V, Ta=25°C	
AL	100	200	IF=0.5mA, V _{CE} =5V, Ta=25°C	
BLL	200	400		
GB	100	600	IF=5mA, V _{CE} =5V, Ta=25°C	
			IF=0.5mA, V _{CE} =5V, Ta=25°C	

- Current Conversion Ratio = $I_C / I_F \times 100\%$

8. Order Information

Part Number

OR-3H7X-W-Y-Z-(CG)

Note

X = CTR Rank (A , B, C, D, AL, BLL, GB or none)

W = Tape and reel option (TP or TP1).

Y = ‘V’ code for VDE safety (This options is not necessary).

Z = ‘G’ code for Halogen free.

CG = Field code.

* VDE Code can be selected.

Option	Description	Packing quantity
TP	Surface mount lead form (low profile) + TP tape & reel option	3000 units per reel
TP1	Surface mount lead form (low profile) + TP1 tape & reel option	3000 units per reel

9. Naming Rule

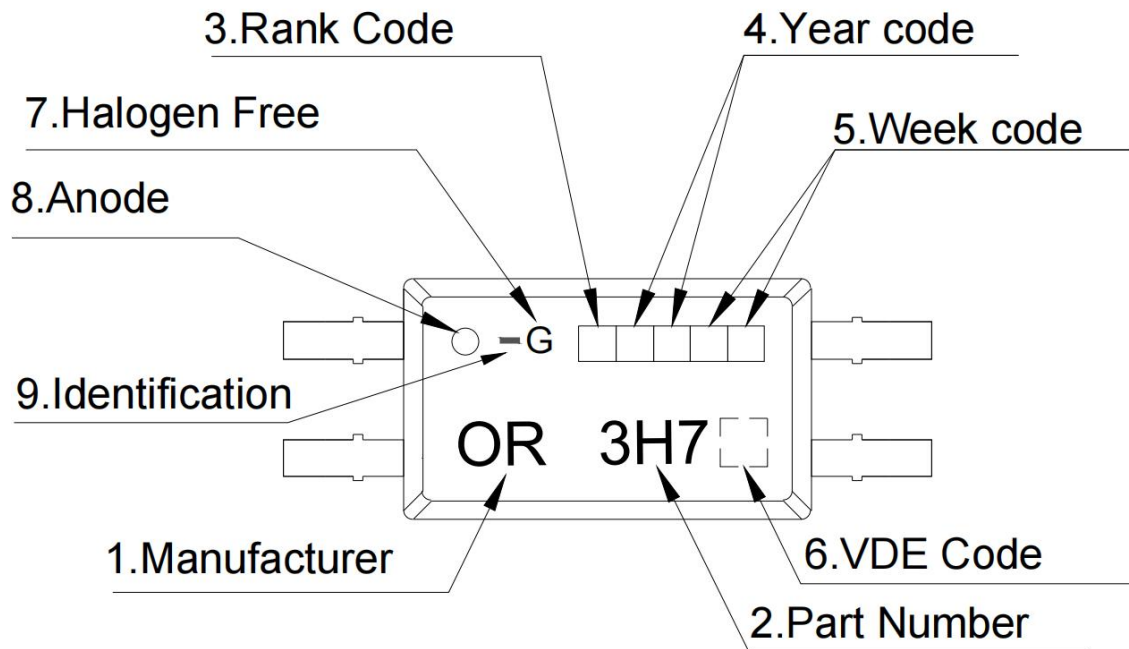

1. Manufacturer : ORIENT.
2. Part Number : 3H7.
3. Rank Code : CTR Rank
4. Year Code : '21' means '2021' and so on.
5. Week Code : 01 means the first week, 02 means the second week and so on.
6. VDE Code . (Optional)
7. HF Code 'G': Halogen Free.
8. Anode.
9. Identification.

* VDE Code can be selected.

10. Outer Dimension

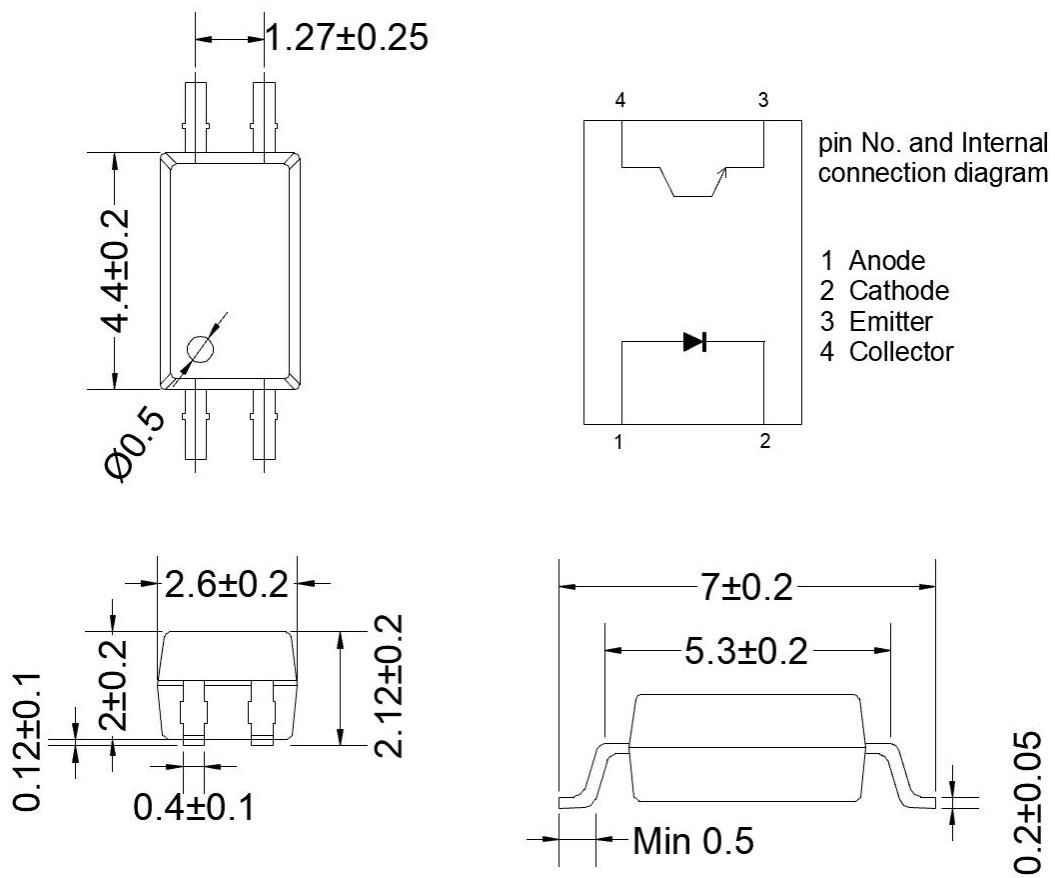

11. Recommended Foot Print Patterns (Mount Pad) (Unit:mm)

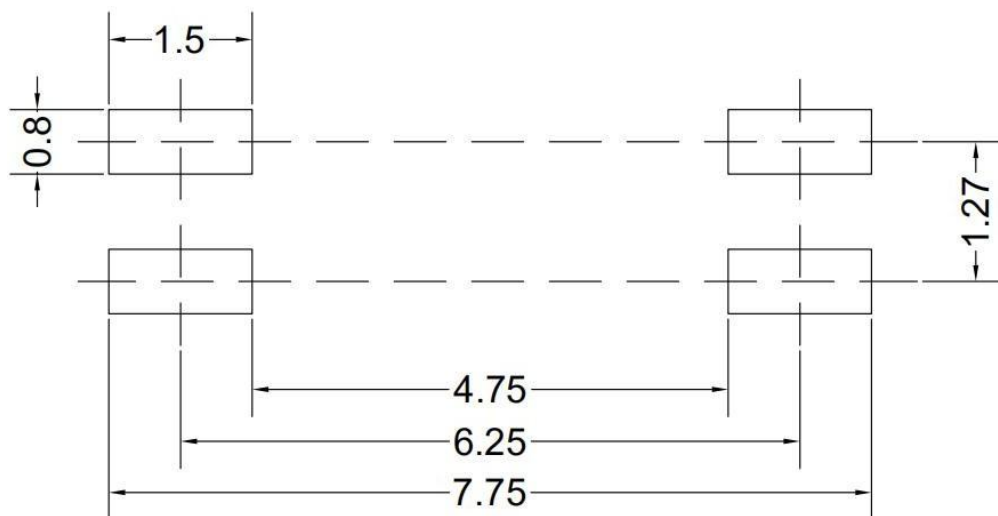

12. Taping Dimensions

(1)OR-3H7-TP

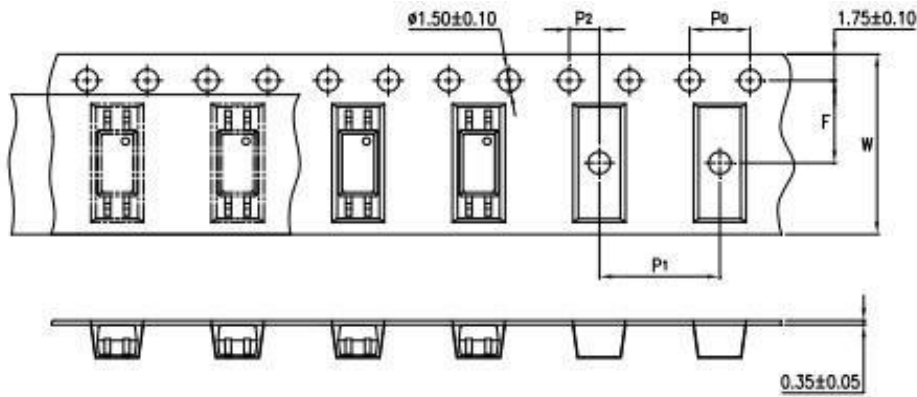

(2)OR-3H7-TP1

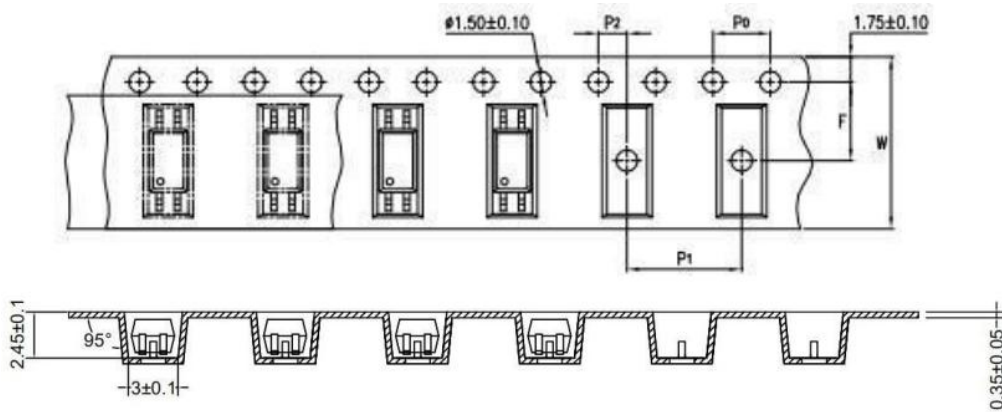

type	Symbol	Dimensions: mm (in.)
bandwidth	W	12±0.3 (0.47)
pitch	P0	4±0.1 (0.15)
pitch	F	5.5±0.1 (0.217)
	P2	2±0.1 (0.079)
interval	P1	8±0.1 (0.315)

Encapsulation type	TP/TP1
Quantity (pieces)	3000

13. Package Dimension

(1) package dimension

Packing Information	
Packing type	Reel type
Tape Width	12mm
Qty per Reel	3,000pcs
Small box (inner) Dimension	345*345*45mm
Large box (Outer) Dimension	480x360x360mm
Max qty per small box	6,000pcs
Max qty per large box	60,000pcs

(2)Packing Label Sample

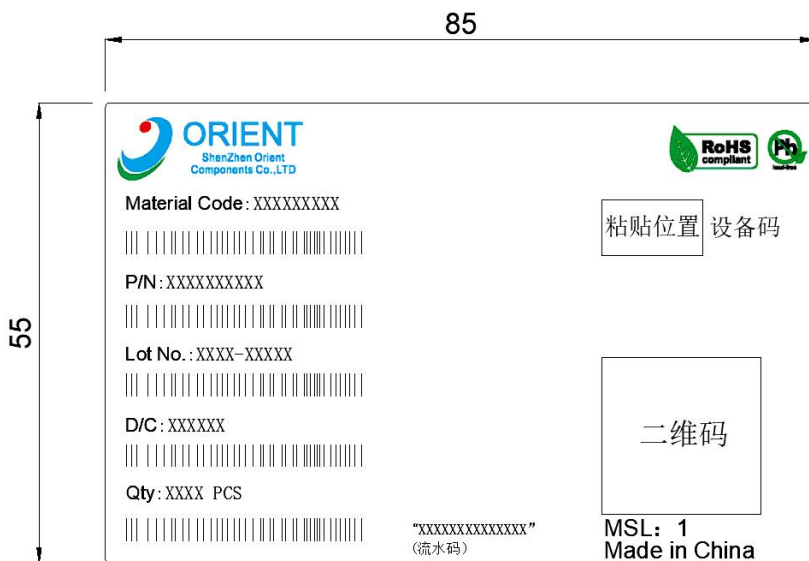

Note:

1. Material Code :Product ID.
2. P/N :Contents with "Order Information" in the specification.
3. Lot No. :Product weeks.
4. D/C :Product data.
5. Quantity :Packaging quantity.

14. Temperature Profile Of Soldering

(1) IR Reflow soldering (JEDEC-STD-020 compliant)

One time soldering reflow is recommended within the condition of temperature and time profile shown below. Do not solder more than three times.

Profile item	Conditions
Preheat	
- Temperature Min (T Smin)	150°C
- Temperature Max (T Smax)	200°C
- Time (min to max) (ts)	90±30 sec
Soldering zone	
- Temperature (TL)	217°C
- Time (t L)	60 sec
Peak Temperature	260°C
Peak Temperature time	20 sec
Ramp-up rate	3°C / sec max.
Ramp-down rate from peak temperature	3~6°C / sec
Reflow times	≤3

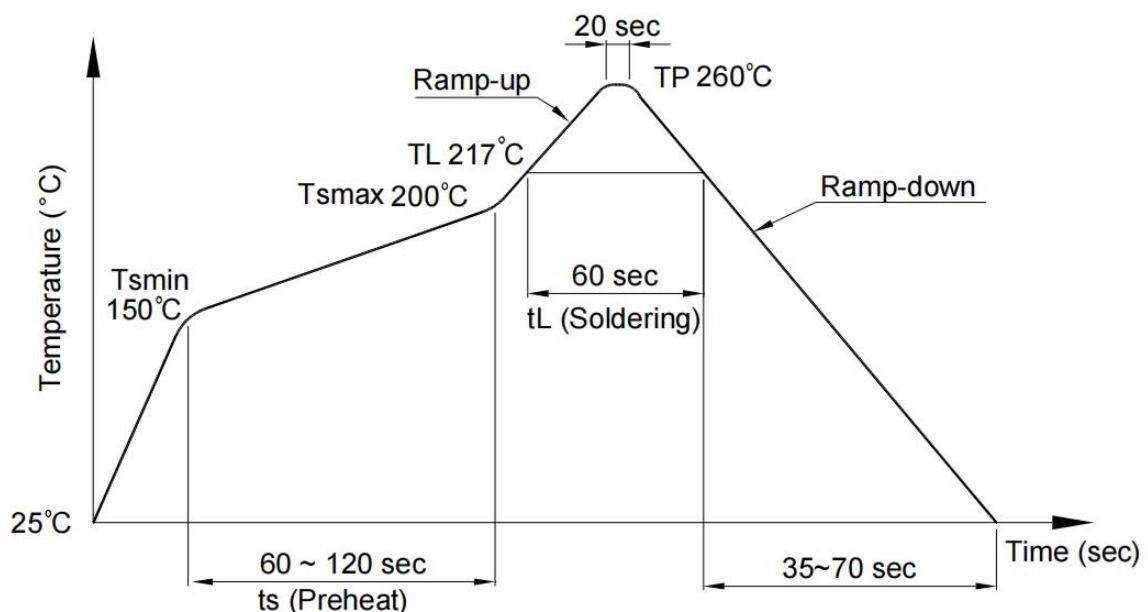

(2) Wave soldering (JEDEC22 A111 compliant)

One time soldering is recommended within the condition of temperature.

Temperature	260+0/-5°C
Time	10 sec
Preheat temperature	25 to 140°C
Preheat time	30 to 80 sec

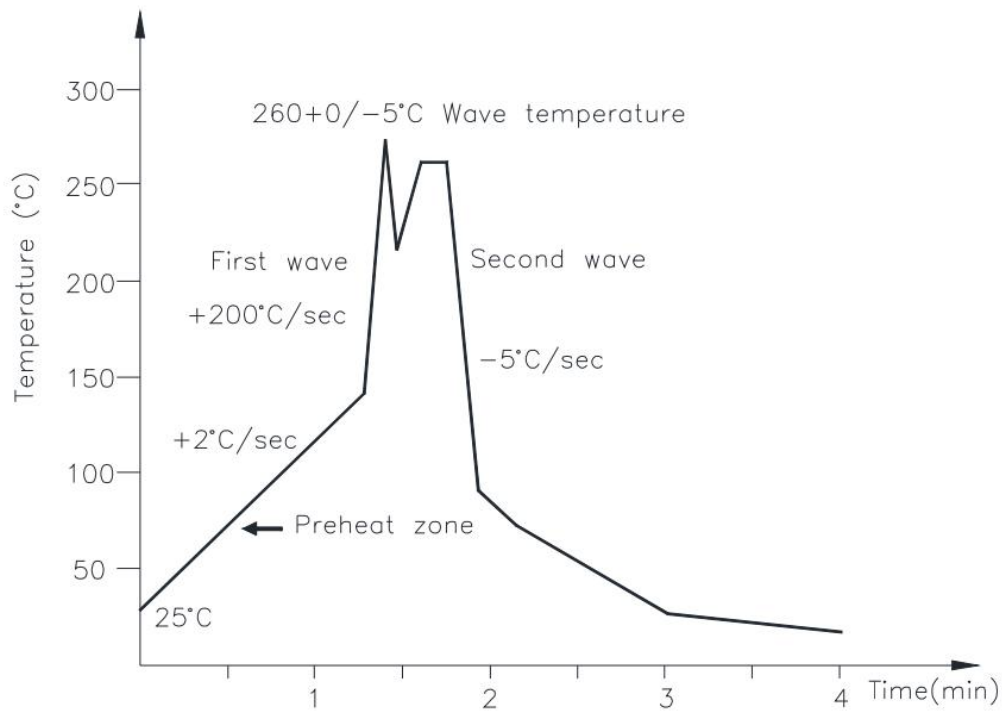

(3) Hand soldering by soldering iron

Allow single lead soldering in every single process. One time soldering is recommended.

Temperature	380+0/-5°C
Time	3 sec max

15. Characteristics Curve

Fig.1 Forward current vs Ambient temperature

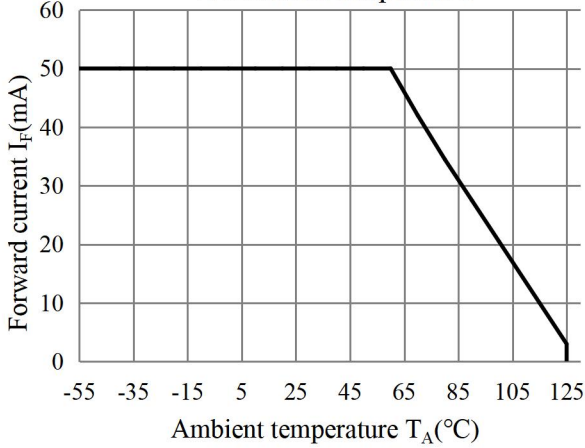

Fig.2 Collector Power Dissipation vs. Ambient temperature

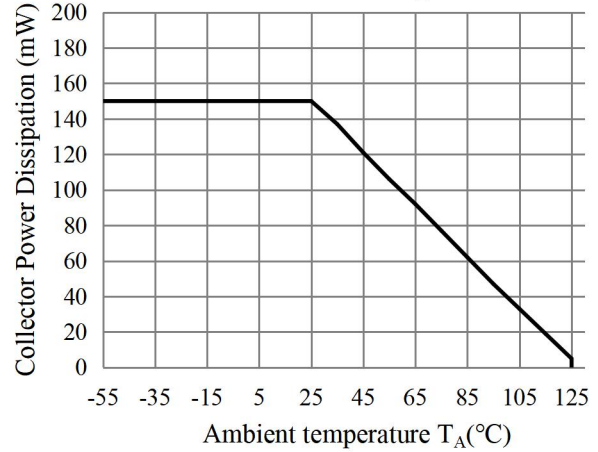

Fig.3 Forward Current vs. Forward Voltage

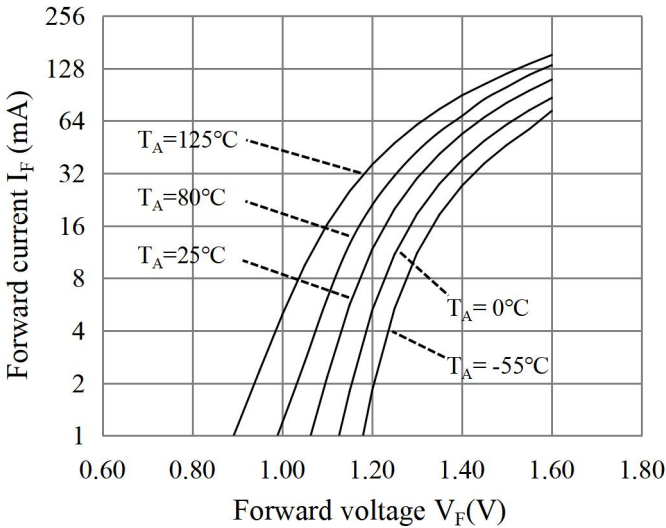

Fig.4 Collector-emitter Saturation Voltage vs. Forward Current

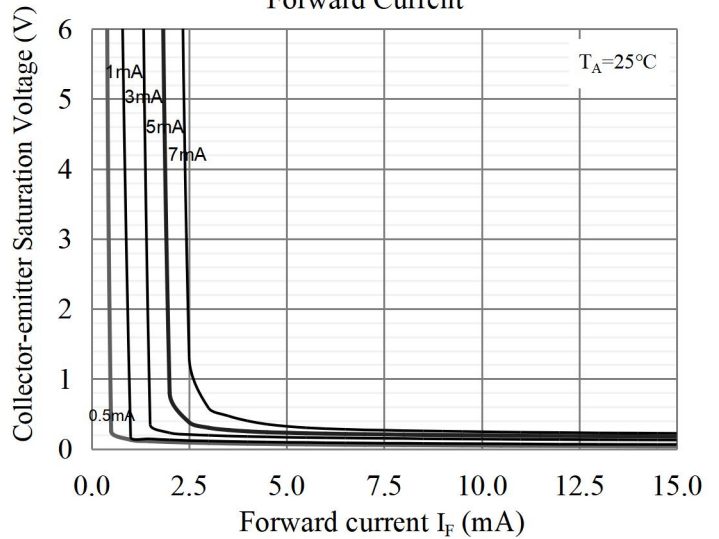

fig.5 Collector Current vs. Non-Saturated Collector Emitter Voltage

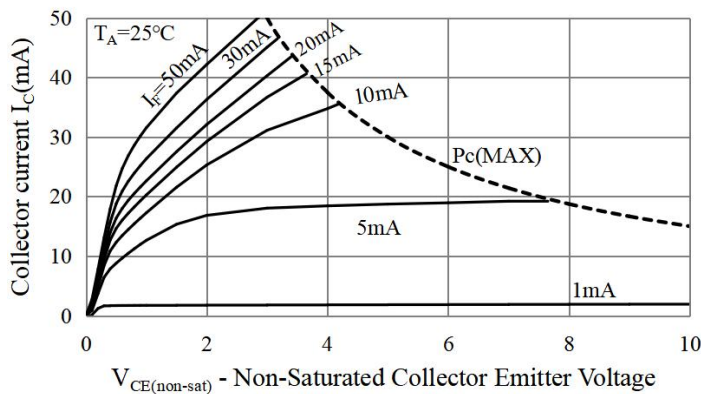

fig.6 Collector Current vs. Non-Saturated Collector Emitter Voltage

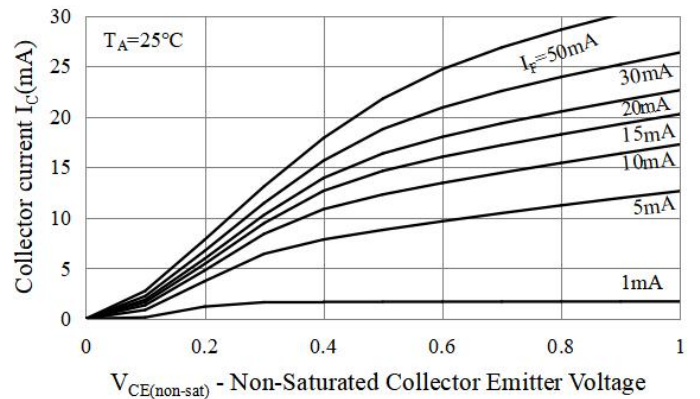

Fig.7 Relative Current Transfer Ratio vs. Ambient Temperature

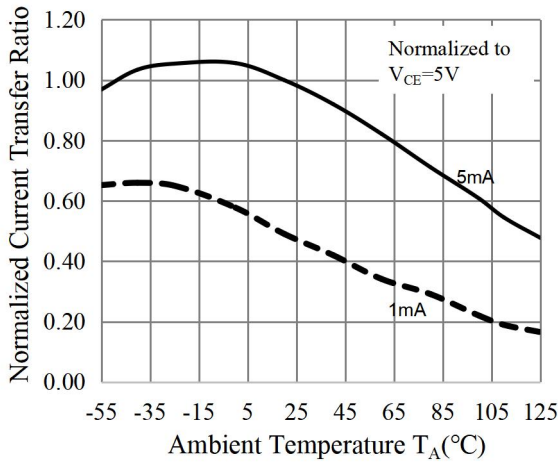

Fig.8 Relative Current Transfer Ratio vs. Ambient Temperature

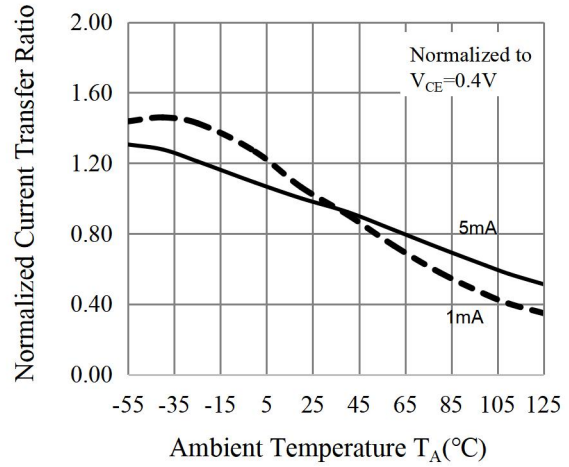

Fig.9 Forward Current vs. Current Transfer Ratio

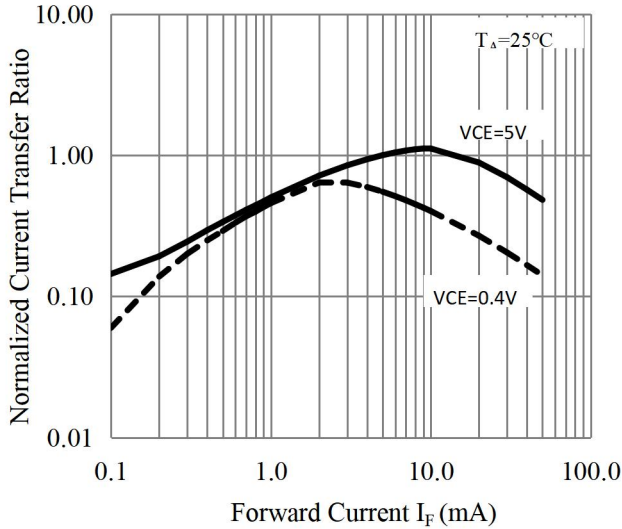

Fig.10 Collector Dark Current vs. Ambient Temperature

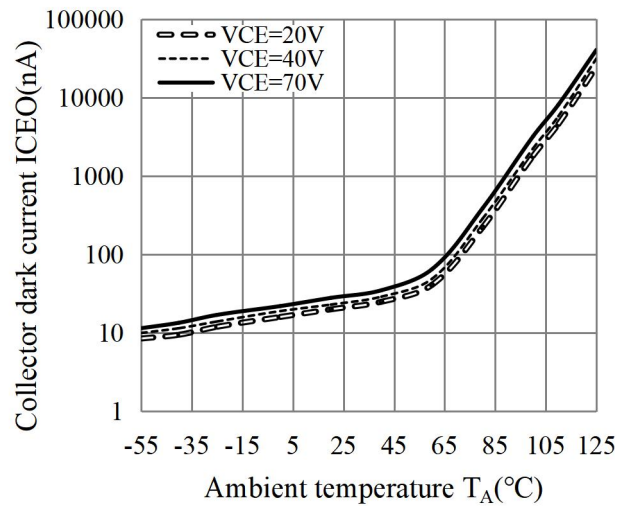

Fig.11 Collector-emitter Saturation Voltage vs. Ambient Temperature

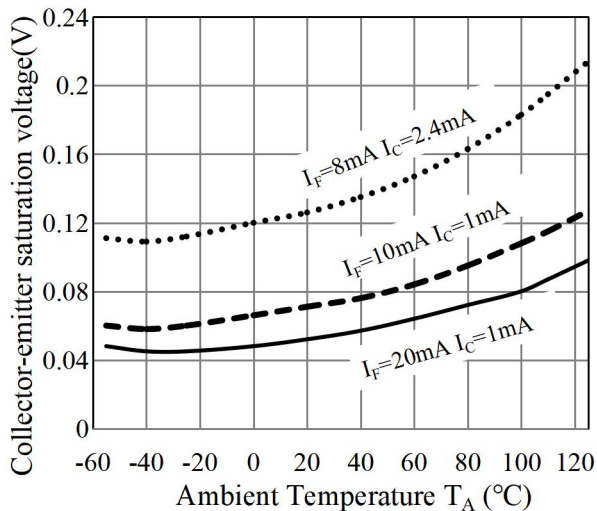

Fig.12 Switching Time vs. Load Resistance

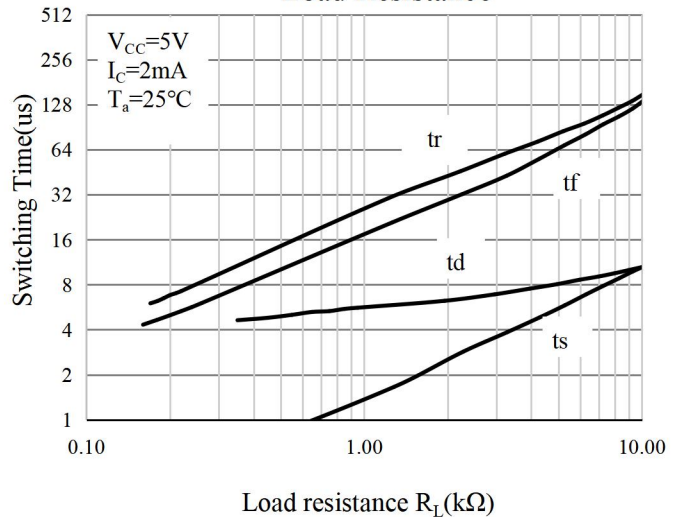

Fig.13 Respnse Time vs. Ambient temperature

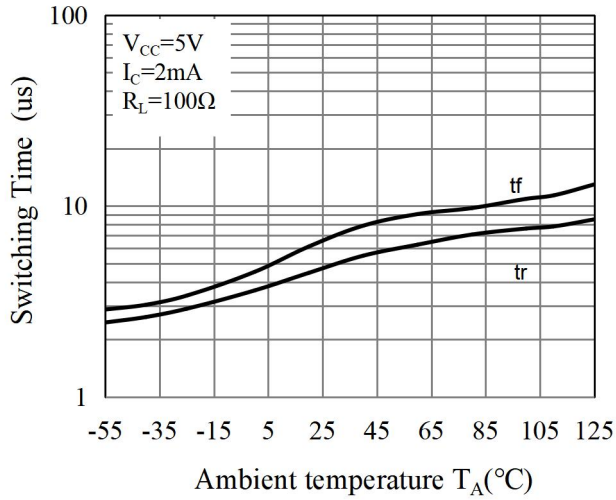
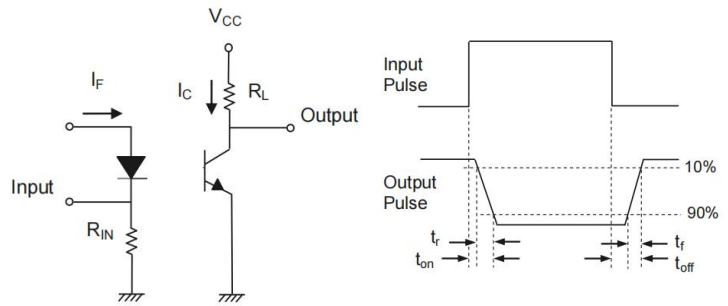

Fig.14 Switching Time Test Circuit & Waveforms



16. NOTES

1. Orient is continually improving the quality, reliability, function or design and Orient reserves the right to make changes without further notices.
2. The products shown in this publication are designed for the general use in electronic applications such as office automation equipment, communications devices, audio/visual equipment, electrical application and instrumentation.
3. For equipment/devices where high reliability or safety is required, such as space applications, nuclear power control equipment, medical equipment, etc, please contact our sales representatives.
4. When requiring a device for any "specific" application, please contact our sales in advice.
5. If there are any questions about the contents of this publication, please contact us at your convenience.
6. The contents described herein are subject to change without prior notice.
7. Immerge unit's body in solder paste is not recommended.